

2026



ÜRÜN KATALOGU



HER DETAYDA SAĞLAMLIK

10 ŞUBAT'TAN İTİBAREN BAYİLİK PANELİMİZİ AKTİF EDİYORUZ!!!

İLKA BAYİLİK PANELİNDE NE GİBİ İŞLEMLER YAPABİLİRİM?

Firmamız tarafından tarafınıza iletilen giriş bilgileriyle bayilik paneline giriş yaparak tüm ürünlerimizi ve güncel kampanyalarımızı görüntüleyebilirsiniz.

İLKA FURNITURE ACCESSORIES

Bayi Girişi Bayi Başvuru Formu

Bayi Girişi

Kullanıcı Adı: Bayi Kodu:

Şifre: Şifre:

Giriş Yap Şifremi Unuttum

E-posta adresinizi giriniz

Faydalı Linkler

- Hakkımızda
- Satış Sözleşmesi
- KVK Sözleşmesi
- Gizlilik ve Güvenlik

Kargo

- İade ve Teslimat
- Bayi Başvuru Formu
- İletişim

Neredeyiz?

- Telefon: 05326302214
- E-Posta: info@ilkaplasi.com.tr
- Adres: İSTASYON M... NO: 8 GEBZE/KOCAELİ

Dilediğiniz ürünü sepetinize ekleyerek siparişinizi oluşturabilir, siparişinize notlar ekleyebilir ve aktif siparişlerinizin durumunu takip edebilirsiniz.

Siparişinizi tamamladıktan sonra veya ödeme yapmak istediğinizde, online tahsilat bölümüne tıklayarak havale/EFT ya da kredi kartı ile ödeme gerçekleştirebilirsiniz.

Geçmiş siparişlerinizi inceleyebilir, bugüne kadar yaptığınız tüm ödemeleri kontrol edebilir, irsaliye ve faturalarınızı anlık olarak görüntüleyebilirsiniz.

Raporlar bölümüne girerek cari hareketlerinize ve cari hesap ekstrenize ulaşabilir, ayrıca alım-satım raporlarınızı görüntüleyebilirsiniz.

Ürün Kodu	Ürün	Marka	Liste Fiyatı	İndirim	Fiyat	Miktar	Tutar	Ekleyen Kullanıcı	Sil
119.401.01	PLASTİK BAŞLI METAL RAF PİMİ BEYAZ		0,31 TL	%19	0,25 TL	100000	25.029,00 TL	demo	X
521.113.01	10CM PLASTİK AYAK #42 BEYAZ		5,55 TL	%19	4,50 TL	900	4.045,95 TL	demo	X
337.059.13	METAL YUVARLAK ASKI FLANŞLAR KROM		7,30 TL	%19	5,91 TL	500	2.956,50 TL	demo	X
282.700.11	BİNGO AYAK SAGI M8		1,17 TL	%19	0,95 TL	9000	8.551,17 TL	demo	X
282.113.01	KÜÇÜK BİNGO AYAK M8 BEYAZ		1,17 TL	%19	0,95 TL	9000	8.551,17 TL	demo	X
337.103.11	OVAL ASKI FLANŞ ÇİNKO		1,36 TL	%19	1,10 TL	4000	4.403,16 TL	demo	X

Sepeti Temizle Sepeti Güncelle

Ara Toplam 66.095,00 TL

Toplam İndirim 12.558,05 TL

Toplam 53.536,95 TL

KDV 10.707,39 TL

Genel Toplam 64.244,34 TL

Siparişi Tamamla

RENK KODLARI

BEYAZ : 01

ÇİNKO : 11

KREM : 02

NIKEL : 12

KAHVE : 03

KROM : 13

SİYAH : 04

MAT KROM : 14

VENGE : 05

GOLD : 15

ŞEFFAF : 06

PVC : 16

GRİ : 07

KRISTAL : 17

MEŞE : 08

ANTRASİT : 09

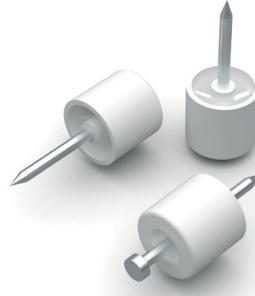

KODU CODE	CİNSİ TYPE	RENK COLOR	MİNİMUM ADET MINIMUM QUANTITY	ÇUVAL ADETİ SACK QUANTITY	FİYAT(₺) PRICE
111.215.RK	EKO ÇİVİLİ RAF RAF PİMİ	RENKLER	1 000	25 000	0,306
111.215.06	EKO ÇİVİLİ RAF RAF PİMİ	ŞEFFAF	1 000	25 000	0,336

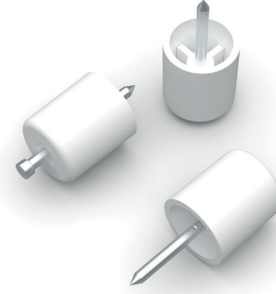

KODU CODE	CİNSİ TYPE	RENK COLOR	MİNİMUM ADET MINIMUM QUANTITY	ÇUVAL ADETİ SACK QUANTITY	FİYAT(₺) PRICE
121.214.RK	LÜKS ÇİVİLİ RAF PİMİ	RENKLER	1 000	25 000	0,31
121.214.06	LÜKS ÇİVİLİ RAF PİMİ	ŞEFFAF	1 000	25 000	0,34



KODU CODE	CİNSİ TYPE	RENK COLOR	MİNİMUM ADET MINIMUM QUANTITY	ÇUVAL ADETİ SACK QUANTITY	FİYAT(₺) PRICE
131.213.RK	EURO ÇİVİLİ RAF PİMİ	RENKLER	1 000	25 000	0,32
131.213.06	EURO ÇİVİLİ RAF PİMİ	ŞEFFAF	1 000	25 000	0,35



FİYATLARIMIZA KDV DAHİL DEĞİLDİR



KODU CODE	CİNSİ TYPE	KAPLAMA TİPİ PLATING TYPE	MİNİMUM ADET MINIMUM QUANTITY	KOLİ ADETİ BOX QUANTITY	FİYAT(₺) PRICE
152.645.12	ÇİVİLİ CONTALI RAF PİMİ	NİKEL	1 000	5 000	4,30

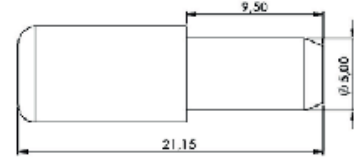
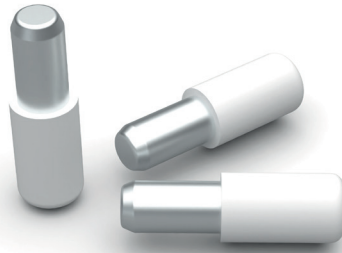

KODU CODE	CİNSİ TYPE	RENK COLOR	MİNİMUM ADET MINIMUM QUANTITY	KOLİ ADETİ BOX QUANTITY	FİYAT(₺) PRICE
119.401.RK	PLASTİK BAŞLIKLIL METAL RAF PİMİ	RENKLER	1 000	10 000	0,57
119.401.06	PLASTİK BAŞLIKLIL METAL RAF PİMİ	ŞEFFAF	1 000	10 000	0,60
119.402.RK	PLASTİK BAŞLIKLIL METAL RAF PİMİ 100'lü	RENKLER	1 000	10 000	0,59
119.402.06	PLASTİK BAŞLIKLIL METAL RAF PİMİ 100'lü	ŞEFFAF	1 000	10 000	0,62

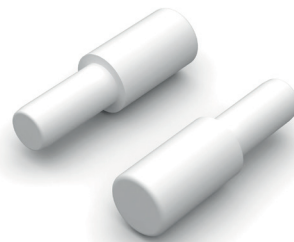
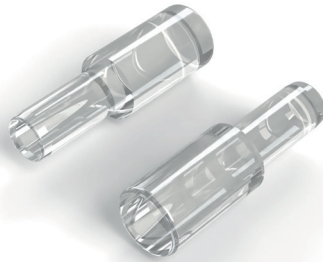

KODU CODE	CİNSİ TYPE	RENK COLOR	MİNİMUM ADET MINIMUM QUANTITY	KOLİ ADETİ BOX QUANTITY	FİYAT(₺) PRICE
125.410.01	PLASTİK KIRILMAZ RAF PİMİ	BEYAZ	1 000	10 000	0,38
125.410.06	PLASTİK KIRILMAZ RAF PİMİ	ŞEFFAF	1 000	10 000	0,44

FİYATLARIMIZA KDV DAHİL DEĞİLDİR



KODU CODE	CİNSİ TYPE	KAPLAMA TİPİ PLATING TYPE	MİNİMUM ADET MINIMUM QUANTITY	KOLİ ADETİ BOX QUANTITY	FİYAT(₺) PRICE
152.201.11	SEGMANLI RAF PİMİ	ÇİNKO	1 000	10 000	0,57



KODU CODE	CİNSİ TYPE	RENK COLOR	MİNİMUM ADET MINIMUM QUANTITY	KOLİ ADETİ BOX QUANTITY	FİYAT(₺) PRICE
153.260.17	KRİSTAL RAF PİMİ	ŞEFFAF	1 000	10 000	1,16



KODU CODE	CİNSİ TYPE	RENK COLOR	MİNİMUM ADET MINIMUM QUANTITY	ÇUVAL ADETİ SACK QUANTITY	FİYAT(₺) PRICE
154.267.16	PVC VANTUZLU RAF PİMİ	ŞEFFAF	1 000	10 000	1,00



KODU CODE	CİNSİ TYPE	KAPLAMA TİPİ PLATING TYPE	MİNİMUM ADET MINIMUM QUANTITY	KUTU ADETİ BOX QUANTITY	FİYAT(₺) PRICE
152.607.12	5MM METAL RAF PİMİ	NİKEL	1 000	10 000	2,30

FİYATLARIMIZA KDV DAHİL DEĞİLDİR



KODU CODE	CİNSİ TYPE	RENK COLOR	MİNİMUM ADET MINIMUM QUANTITY	ÇUVAL ADETİ SACK QUANTITY	FİYAT(₺) PRICE
151.013.RK	5MM PLASTİK GEÇME RAF PİMİ	RENKLER	4 000	40 000	0,21

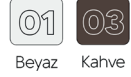
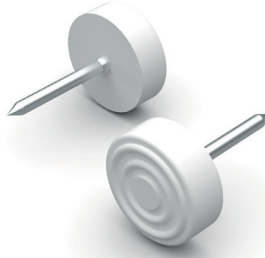

KODU CODE	CİNSİ TYPE	RENK COLOR	MİNİMUM ADET MINIMUM QUANTITY	ÇUVAL ADETİ SACK QUANTITY	FİYAT(₺) PRICE
212.110.RK	ÇİVİLİ POLİGRİT (ÇİVİLİ PABUÇ)	RENKLER	1 000	20 000	0,45
212.110.06	ÇİVİLİ POLİGRİT (ÇİVİLİ PABUÇ)	ŞEFFAF	1 000	20 000	0,48



KODU CODE	CİNSİ TYPE	RENK COLOR	MİNİMUM ADET MINIMUM QUANTITY	ÇUVAL ADETİ SACK QUANTITY	FİYAT(₺) PRICE
214.169.16	PVC YUMUŞAK POLİGRİT	ŞEFFAF	1 000	20 000	0,60



KODU CODE	CİNSİ TYPE	RENK COLOR	MİNİMUM ADET MINIMUM QUANTITY	KOLİ ADETİ BOX QUANTITY	FİYAT(₺) PRICE
221.013.RK	PLASTİK BAZA PABUCU	RENKLER	500	10 000	0,58
221.013.06	PLASTİK BAZA PABUCU	ŞEFFAF	500	10 000	0,66



FİYATLARIMIZA KDV DAHİL DEĞİLDİR

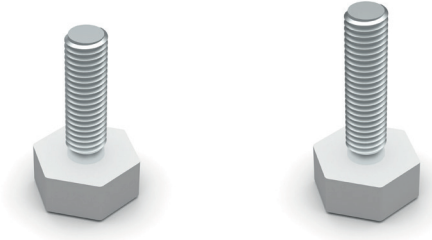

KODU CODE	CİNSİ TYPE	RENK COLOR	MİNİMUM ADET MINIMUM QUANTITY	KOLİ ADETİ BOX QUANTITY	FİYAT(₺) PRICE
231.210.RK	ALTI KÖŞE BİNGO AYAK M6 29MM	RENKLER	200	2 400	2,80
232.118.RK	ALTI KÖŞE BİNGO AYAK M6 33MM	RENKLER	200	2 400	2,80

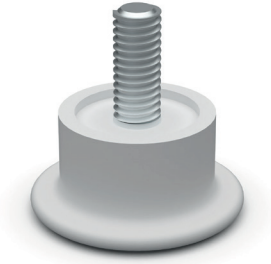
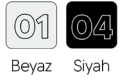

KODU CODE	CİNSİ TYPE	RENK COLOR	MİNİMUM ADET MINIMUM QUANTITY	ÇUVAL ADETİ SACK QUANTITY	FİYAT(₺) PRICE
262.115.RK	KÜÇÜK BİNGO AYAK M6	RENKLER	200	3 000	2,40

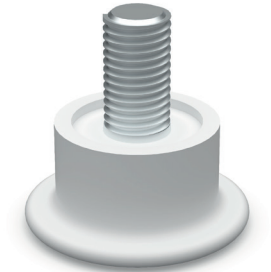
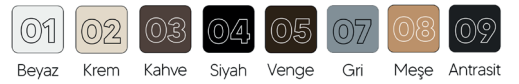

KODU CODE	CİNSİ TYPE	RENK COLOR	MİNİMUM ADET MINIMUM QUANTITY	ÇUVAL ADETİ SACK QUANTITY	FİYAT(₺) PRICE
282.113.RK	KÜÇÜK BİNGO AYAK M8	RENKLER	200	3 000	2,40



FİYATLARIMIZA KDV DAHİL DEĞİLDİR



KODU CODE	CİNSİ TYPE	RENK COLOR	MİNİMUM ADET MINIMUM QUANTITY	ÇUVAL ADETİ SACK QUANTITY	FİYAT(₺) PRICE
281.215.04	BÜYÜK BİNGO AYAK M8	RENKLER	200	2 000	3,00

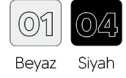

KODU CODE	CİNSİ TYPE	KAPLAMA TİPİ PLATING TYPE	MİNİMUM ADET MINIMUM QUANTITY	KOLİ ADETİ BOX QUANTITY	FİYAT(₺) PRICE
262.702.11	BİNGO AYAK SACI M6	ÇİNKO	200	3 000	2,40
282.700.11	BİNGO AYAK SACI M8	ÇİNKO	200	3 000	2,40



KODU CODE	CİNSİ TYPE	RENK COLOR	ÇAP DİAMETER	KOLİ ADETİ BOX QUANTITY	FİYAT(₺) PRICE
21.89.025	10 CM PLASTİK AYAK	BEYAZ	42	300	12,00
22.89.025	10 CM PLASTİK AYAK	SİYAH	42	300	12,00
21.89.025	10 CM PLASTİK AYAK	ANTRASİT	42	300	12,00



FİYATLARIMIZA KDV DAHİL DEĞİLDİR



KODU CODE	CİNSİ TYPE	RENK COLOR	MİNİMUM ADET MINIMUM QUANTITY	KOLİ ADETİ BOX QUANTITY	FİYAT(₺) PRICE
423.066.06	AÇILI ÇEKTİRME (T BAĞLANTI)	ŞEFFAF	100	2 000	3,20
423.066.01	AÇILI ÇEKTİRME (T BAĞLANTI)	BEYAZ	100	2 000	3,20



KODU CODE	CİNSİ TYPE	RENK COLOR	MİNİMUM ADET MINIMUM QUANTITY	ÇUVAL ADETİ SACK QUANTITY	FİYAT(₺) PRICE
411.018.RK	PLASTİK L KÖŞE	RENKLER	250	5 000	0,66
411.018.06	PLASTİK L KÖŞE	ŞEFFAF	250	5 000	0,74

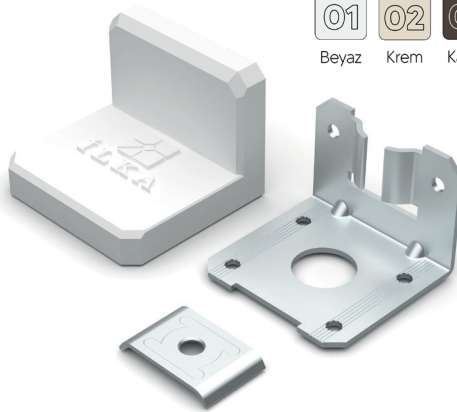

KODU CODE	CİNSİ TYPE	RENK COLOR	SAC KALINLIĞI SHEET THICKNESS	KUTU ADETİ BOX QUANTITY	FİYAT(₺) PRICE
313.114.RK	LÜKS DOLAP ASKI ELEMANI	RENKLER	1.50MM	250	7,70



FİYATLARIMIZA KDV DAHİL DEĞİLDİR

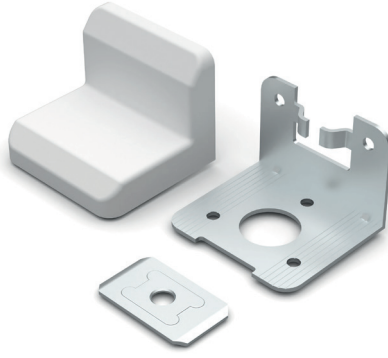

KODU CODE	CİNSİ TYPE	RENK COLOR	SAC KALINLIĞI SHEET THICKNESS	KUTU ADETİ BOX QUANTITY	FİYAT(₺) PRICE
211.501.RK	DOLAP ASKI ELEMANI	RENKLER	1,20MM	250	4,70
211.203.RK	DOLAP ASKI ELEMANI	RENKLER	1,50MM	250	5,70

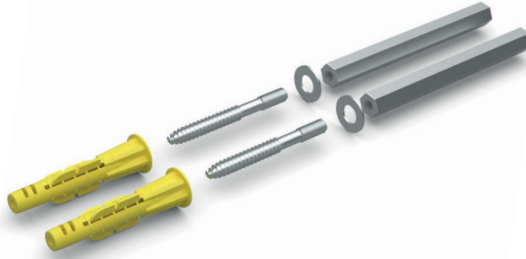

KODU CODE	CİNSİ TYPE	ÇAP DİAMETER	UZUNLUK LENGTH	KOLİ ADETİ BOX QUANTITY	FİYAT(₺) PRICE
321.102.11	GİZLİ RAF TUTUCU	8MM	100MM	200	31,00
321.201.11	GİZLİ RAF TUTUCU	8MM	140MM	150	37,00
321.300.11	GİZLİ RAF TUTUCU	10MM	100MM	150	38,00
321.409.11	GİZLİ RAF TUTUCU	10MM	140MM	150	46,00



KODU CODE	CİNSİ TYPE	KAPLAMA TİPİ PLATING TYPE	MİNİMUM ADET MINIMUM QUANTITY	KOLİ ADETİ BOX QUANTITY	FİYAT(₺) PRICE
442.104.11	KARYOLA DEMİRİ 1,20MM	ÇİNKO	100	500	7,70
264.002.11	KARYOLA DEMİRİ 1,20MM (TAKIM)	ÇİNKO	50	100	46,00

FİYATLARIMIZA KDV DAHİL DEĞİLDİR

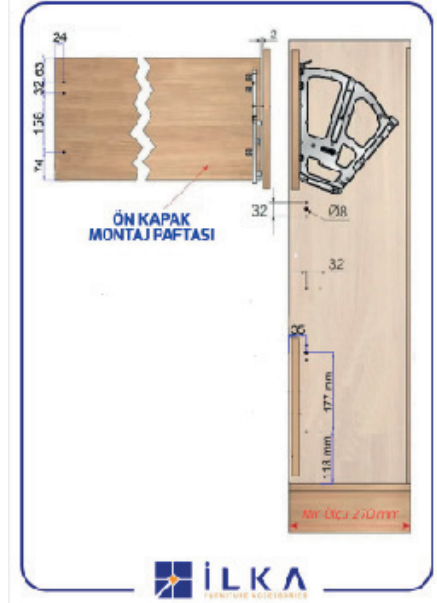

KODU CODE	CİNSİ TYPE	RENK COLOR	MİNİMUM ADET MINIMUM QUANTITY	KOLİ ADETİ BOX QUANTITY	FİYAT(₺) PRICE
821.015.11	PLASTİK İKİLİ AYAKAKBILIK APARATI	RENKLER	20	50	60,00



KODU CODE	CİNSİ TYPE	RENK COLOR	KAPLAMA TİPİ PLATING TYPE	KOLİ ADETİ BOX QUANTITY	FİYAT(₺) PRICE
709.430.11	SABİT MİNİ TEKERLEK	SİYAH	ÇİNKO	500	8,00



KODU CODE	CİNSİ TYPE	RENK COLOR	MİNİMUM ADET MINIMUM QUANTITY	ÇUVAL ADETİ SACK QUANTITY	FİYAT(₺) PRICE
821.084.20	ROKET DÜBEL 8MM	SARI	500	10 000	0,44
821.086.20	ROKET DÜBEL 10MM	SARI	500	5 000	0,66

FİYATLARIMIZA KDV DAHİL DEĞİLDİR



KODU CODE	CİNSİ TYPE	RENK COLOR	MİNİMUM ADET MINIMUM QUANTITY	KUTU ADETİ BOX QUANTITY	FİYAT(₺) PRICE
331.415.01	PLASTİK OVAL ASKI FLANŞ	BEYAZ	200	1 400	1,20
331.415.06	PLASTİK OVAL ASKI FLANŞ	ŞEFFAF	200	1 400	2,76

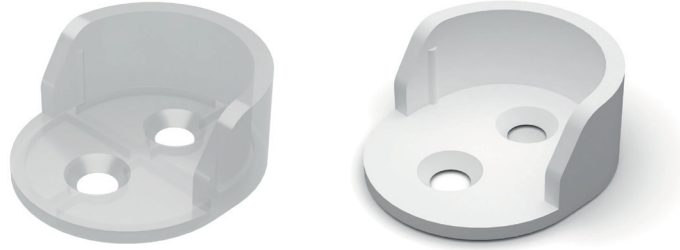

KODU CODE	CİNSİ TYPE	RENK COLOR	MİNİMUM ADET MINIMUM QUANTITY	KUTU ADETİ BOX QUANTITY	FİYAT(₺) PRICE
244.029.01	PLASTİK YARIM AY ASKI FLANŞ	BEYAZ	200	1 400	2,12
244.029.06	PLASTİK YARIM AY ASKI FLANŞ	ŞEFFAF	200	1 400	3,00



KODU CODE	CİNSİ TYPE	RENK COLOR	MİNİMUM ADET MINIMUM QUANTITY	KOLİ ADETİ BOX QUANTITY	FİYAT(₺) PRICE
244.021.06	PLASTİK YUVARLAK ASKI FLANŞ	ŞEFFAF	100	1 000	9,00



KODU CODE	CİNSİ TYPE	MATERYAL MATERIEL	KAPLAMA TİPİ PLATING TYPE	MİNİMUM ADET MINIMUM QUANTITY	ÇUVAL ADETİ SACK QUANTITY	FİYAT(₺) PRICE
337.103.11	OVAL ASKI FLANŞ	SAC	ÇİNKO	250	4 000	2,50
336.007.12	OVAL ASKI FLANŞ	SAC	NİKEL	250	4 000	3,60

FİYATLARIMIZA KDV DAHİL DEĞİLDİR

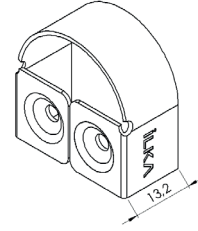
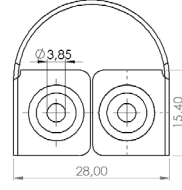
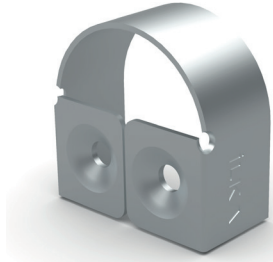

KODU CODE	CİNSİ TYPE	MATERYAL MATERIEL	KAPLAMA TİPİ PLATING TYPE	MİNİMUM ADET MINIMUM QUANTITY	ÇUVAL ADETİ SACK QUANTITY	FİYAT(₺) PRICE
337.004.11	İKİ DELİK ASKI FLANŞ	SAC	ÇİNKO	250	4 000	2,00
337.004.12	İKİ DELİK ASKI FLANŞ	SAC	NİKEL	250	4 000	3,80



KODU CODE	CİNSİ TYPE	MATERYAL MATERIEL	KAPLAMA TİPİ PLATING TYPE	MİNİMUM ADET MINIMUM QUANTITY	KOLİ ADETİ BOX QUANTITY	FİYAT(₺) PRICE
337.059.13	YUVARLAK ASKI FLANŞ	SAC	KROM	250	500	14,00



KODU CODE	CİNSİ TYPE	MATERYAL MATERIEL	KAPLAMA TİPİ PLATING TYPE	MİNİMUM ADET MINIMUM QUANTITY	ÇUVAL ADETİ SACK QUANTITY	FİYAT(₺) PRICE
336.205.11	LÜKS OVAL ASKI FLANŞ	ZAMAK	ÇİNKO	250	1 000	5,10
336.205.12	LÜKS OVAL ASKI FLANŞ	ZAMAK	NİKEL	250	1 000	6,90

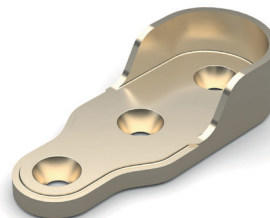

KODU CODE	CİNSİ TYPE	MATERYAL MATERIEL	KAPLAMA TİPİ PLATING TYPE	MİNİMUM ADET MINIMUM QUANTITY	ÇUVAL ADETİ SACK QUANTITY	FİYAT(₺) PRICE
337.301.11	APEX OVAL ASKI FLANŞ	ZAMAK	ÇİNKO	250	1 000	4,60
337.301.12	APEX OVAL ASKI FLANŞ	ZAMAK	NİKEL	250	1 000	6,00

FİYATLARIMIZA KDV DAHİL DEĞİLDİR



KODU CODE	CİNSİ TYPE	KAPLAMA TİPİ PLATING TYPE	MİNİMUM ADET MINIMUM QUANTITY	KOLİ ADETİ BOX QUANTITY	FİYAT(₺) PRICE
171.380.RK	13MM VİDA KAPAMA	RENKLER	250	5 000	5,36
171.580.RK	15MM VİDA KAPAMA	RENKLER	250	5 000	5,60
172.080.RK	20MM VİDA KAPAMA	RENKLER	200	5 000	7,90
172.580.RK	25MM VİDA KAPAMA	RENKLER	200	2 000	20,00
193.080.RK	30MM VİDA KAPAMA	RENKLER	200	2 000	35,00





KODU CODE	CİNSİ TYPE	MATERYAL MATERIEL	KAPLAMA TİPİ PLATING TYPE	MİNİMUM ADET MINIMUM QUANTITY	KOLİ ADETİ BOX QUANTITY	FİYAT(₺) PRICE
431.702.11	MİNİFİX GÖVDE 13x18MM	ZAMAK	ÇİNKO	1 000	4 000	2,28
431.702.12	MİNİFİX GÖVDE 13x18MM	ZAMAK	NİKEL	1 000	4 000	3,24



KODU CODE	CİNSİ TYPE	MATERYAL MATERIEL	KAPLAMA TİPİ PLATING TYPE	MİNİMUM ADET MINIMUM QUANTITY	KOLİ ADETİ BOX QUANTITY	FİYAT(₺) PRICE
432.600.11	MİNİFİX MİLİ	METAL	ÇİNKO	1 000	2 000	1,44



KODU CODE	CİNSİ TYPE	ÇAP DİAMETER	KAPLAMA TİPİ PLATING TYPE	MİNİMUM ADET MINIMUM QUANTITY	KOLİ ADETİ BOX QUANTITY	FİYAT(₺) PRICE
432.105.11	KENDİNDEN DÜBELLİ MİL	8	ÇİNKO	1 000	4 000	1,68
432.204.11	KENDİNDEN DÜBELLİ MİL	10	ÇİNKO	1 000	4 000	1,68

FİYATLARIMIZA KDV DAHİL DEĞİLDİR



KODU CODE	CİNSİ TYPE	MATERYAL MATERIEL	KAPLAMA TİPİ PLATING TYPE	MİNİMUM ADET MINIMUM QUANTITY	KOLİ ADETİ BOX QUANTITY	FİYAT(₺) PRICE
433.409.11	ZAMAK DÜBEL M6 8x13MM	ZAMAK	ÇİNKO	1 000	2 000	1,44



KODU CODE	CİNSİ TYPE	RENK COLOR	MİNİMUM ADET MINIMUM QUANTITY	ÇUVAL ADETİ SACK QUANTITY	FİYAT(₺) PRICE
433.119.01	PLASTİK KAVALYE	BEYAZ	1 000	20 000	0,32
433.119.04	PLASTİK KAVALYE	SİYAH	1 000	20 000	0,24



KODU CODE	CİNSİ TYPE	EBAT DIMENSIONS	MİNİMUM ADET MINIMUM QUANTITY	ÇUVAL ADETİ SACK QUANTITY	FİYAT(₺) PRICE
433.201.06	PLASTİK ŞERİT DÜBEL	8x11	1 000	20 000	0,288
433.300.06	PLASTİK ŞERİT DÜBEL	8x13	1 000	20 000	0,288
433.102.06	PLASTİK ŞERİT DÜBEL	10x13	1 000	20 000	0,320

FİYATLARIMIZA KDV DAHİL DEĞİLDİR

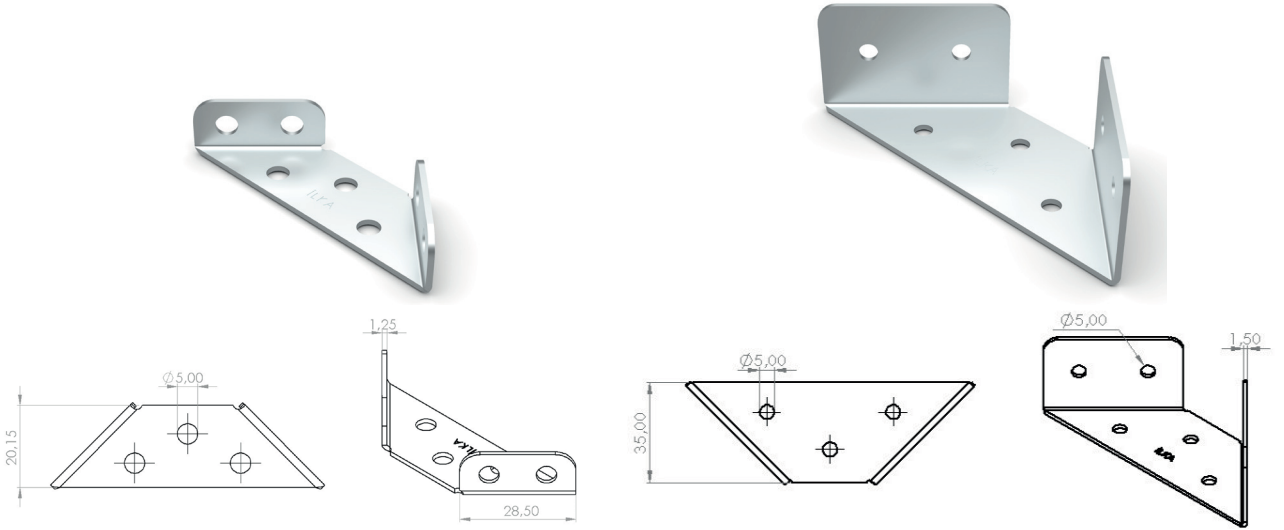

KODU CODE	CİNSİ TYPE	MATERYAL MATERIEL	KAPLAMA TİPİ PLATING TYPE	KOLİ ADETİ BOX QUANTITY	FİYAT(₺) PRICE
610.022.11	ÇOK AMAÇLI KÖŞE BAĞLANTI	SAC	ÇİNKO	500	3,34
610.015.11	ÇOK AMAÇLI KÖŞE BAĞLANTI BÜYÜK	SAC	ÇİNKO	300	13,70

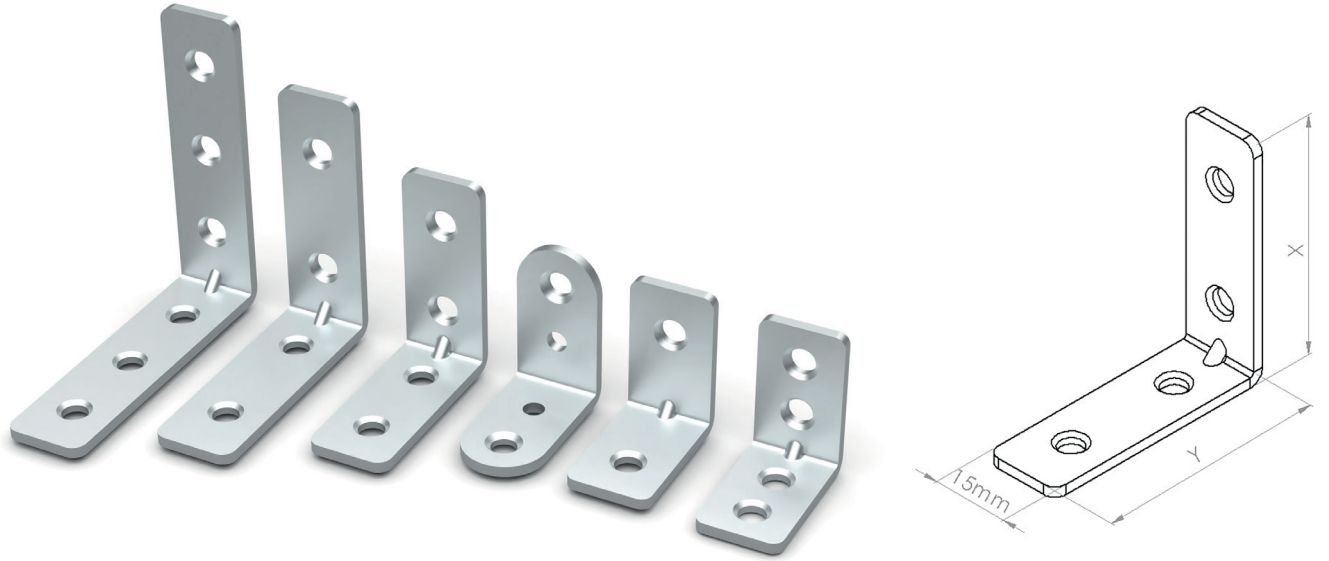

KODU CODE	CİNSİ TYPE	GENİŞLİK WIDTH	X UZUNLUK X LENGHT	Y UZUNLUK Y LENGHT	MİNİMUM ADET MINIMUM QUANTITY	KOLİ ADETİ BOX QUANTITY	FİYAT(₺) PRICE
612.101.11	METAL L GÖNYE 1MM	15	25	25	250	2 000	1,20
612.118.11	METAL L GÖNYE 2MM	15	25	25	250	2 000	1,72
612.125.11	METAL L GÖNYE 2MM Ç.D.	15	25	25	250	2 000	1,72
612.132.11	METAL OVAL L GÖNYE 2MM	15	27	27	250	2 000	1,80
612.149.11	METAL L GÖNYE 2MM	15	35	35	250	1 500	2,16
612.156.11	METAL L GÖNYE 2MM	15	45	45	250	1 000	3,30
612.163.11	METAL L GÖNYE 2MM	15	55	55	250	1 000	3,80

FİYATLARIMIZA KDV DAHİL DEĞİLDİR



KODU CODE	CİNSİ TYPE	GENİŞLİK WIDTH	X UZUNLUK X LENGHT	Y UZUNLUK Y LENGHT	MİNİMUM ADET MINIMUM QUANTITY	KOLİ ADETİ BOX QUANTITY	FİYAT(₺) PRICE
612.231.11	METAL OVAL L GÖNYE 1MM	23	30	30	250	2 000	1,80
612.217.11	METAL OVAL L GÖNYE 1.5MM	23	30	30	250	1 500	2,44
612.224.11	METAL OVAL L GÖNYE 2MM	23	30	30	250	1 500	2,90



KODU CODE	CİNSİ TYPE	GENİŞLİK WIDTH	X UZUNLUK X LENGHT	Y UZUNLUK Y LENGHT	MİNİMUM ADET MINIMUM QUANTITY	KOLİ ADETİ BOX QUANTITY	FİYAT(₺) PRICE
612.309.11	METAL L GÖNYE 1MM	30	25	25	250	1 500	1,80
612.316.11	METAL L GÖNYE 2MM	30	25	25	250	1 500	3,10
612.323.11	METAL L GÖNYE 2MM	30	35	35	250	1 000	4,50
612.330.11	METAL L GÖNYE 2MM	30	45	45	250	1 000	5,80
612.347.11	METAL L GÖNYE 2MM	30	55	55	200	800	7,10



KODU CODE	CİNSİ TYPE	GENİŞLİK WIDTH	X UZUNLUK X LENGHT	Y UZUNLUK Y LENGHT	MİNİMUM ADET MINIMUM QUANTITY	KOLİ ADETİ BOX QUANTITY	FİYAT(₺) PRICE
612.415.11	METAL L GÖNYE 2MM	40	40	40	250	1 000	7,50
612.422.11	METAL L GÖNYE 2MM	40	50	50	200	800	9,20
612.439.11	METAL L GÖNYE 2MM	40	60	60	100	400	11,70
612.446.11	METAL L GÖNYE 3MM	40	75	75	200	200	20,00
612.453.11	METAL L GÖNYE 2MM	40	80	80	100	400	14,30
612.460.11	METAL L GÖNYE 2MM	40	100	100	100	400	18,70

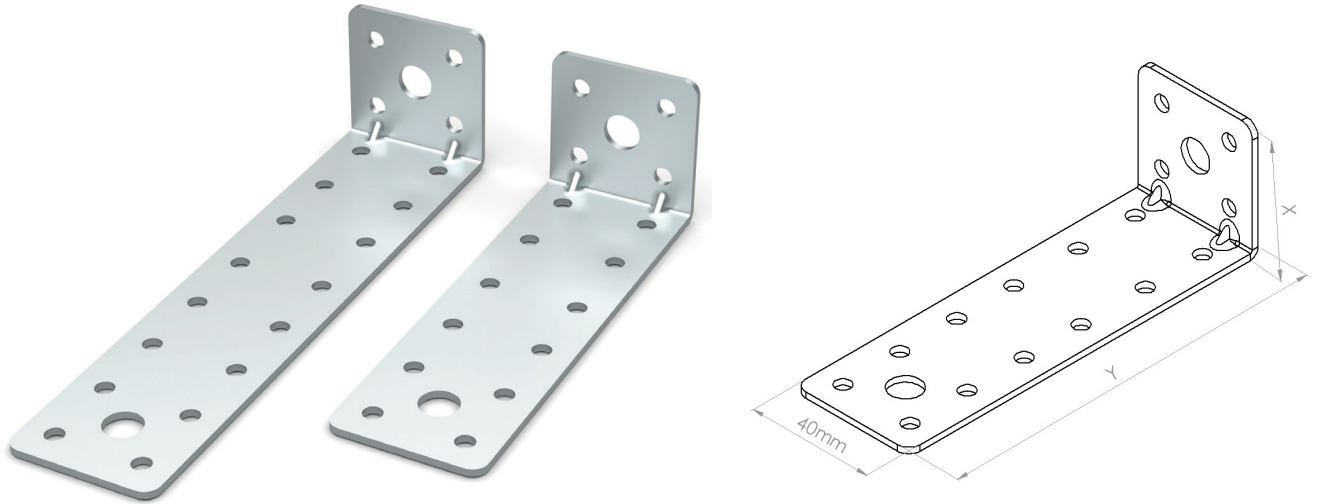

KODU CODE	CİNSİ TYPE	GENİŞLİK WIDTH	X UZUNLUK X LENGHT	Z UZUNLUK Z LENGHT	MİNİMUM ADET MINIMUM QUANTITY	KOLİ ADETİ BOX QUANTITY	FİYAT(₺) PRICE
613.412.11	DEPREM GÖNYESİ 2MM	40	40	120	250	2 000	14,30
613.429.11	DEPREM GÖNYESİ 2MM	40	40	160	250	1 500	18,70

FİYATLARIMIZA KDV DAHİL DEĞİLDİR



KODU CODE	ÇİNSİ TYPE	GENİŞLİK WIDTH	X UZUNLUK X LENGHT	Y UZUNLUK Y LENGHT	MİNİMUM ADET MINIMUM QUANTITY	KOLİ ADETİ BOX QUANTITY	FİYAT(₺) PRICE
612.613.11	METAL L GÖNYE 2MM	60	40	40	250	1 000	11,00
612.620.11	METAL L GÖNYE 2MM	60	60	60	100	400	16,50
612.606.11	METAL L GÖNYE 3MM	60	75	75	200	200	30,00
612.637.11	METAL L GÖNYE 2MM	60	80	80	100	400	24,00
612.644.11	METAL L GÖNYE 2MM	60	100	100	100	400	27,00
612.668.11	METAL L GÖNYE 2MM	60	120	120	250	250	33,00

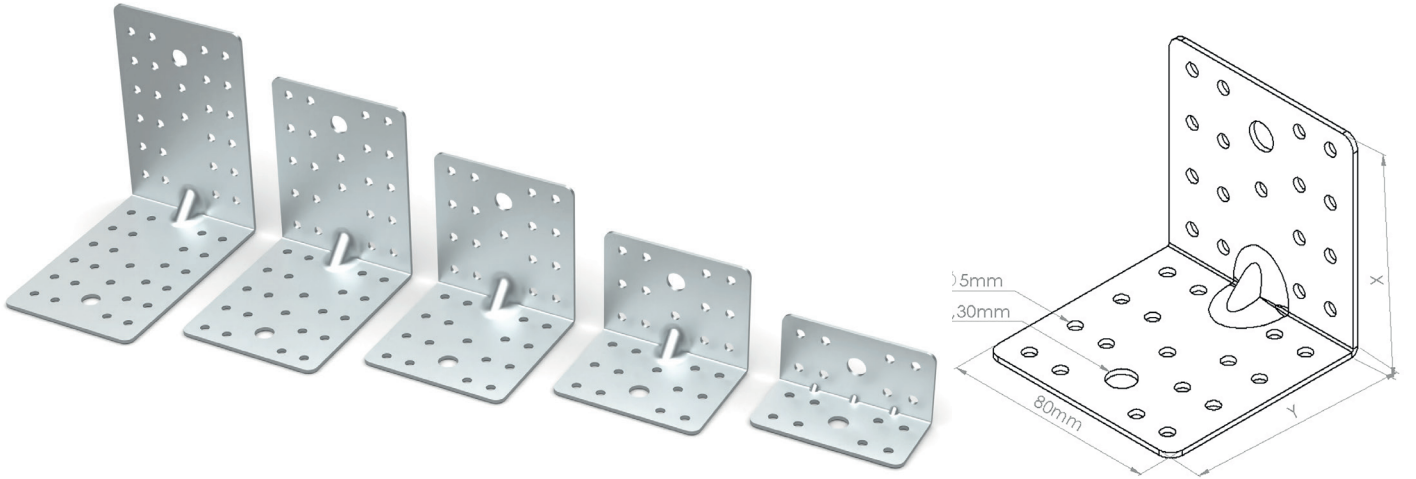

KODU CODE	ÇİNSİ TYPE	GENİŞLİK WIDTH	X UZUNLUK X LENGHT	Y UZUNLUK Y LENGHT	MİNİMUM ADET MINIMUM QUANTITY	KOLİ ADETİ BOX QUANTITY	FİYAT(₺) PRICE
612.811.11	METAL L GÖNYE 2MM	80	40	40	300	300	14,30
612.828.11	METAL L GÖNYE 2MM	80	60	60	150	150	23,00
612.835.11	METAL L GÖNYE 2MM	80	80	80	100	100	28,60
612.842.11	METAL L GÖNYE 2MM	80	100	100	100	100	37,40
612.859.11	METAL L GÖNYE 2MM	80	120	120	50	50	44,00

FİYATLARIMIZA KDV DAHİL DEĞİLDİR

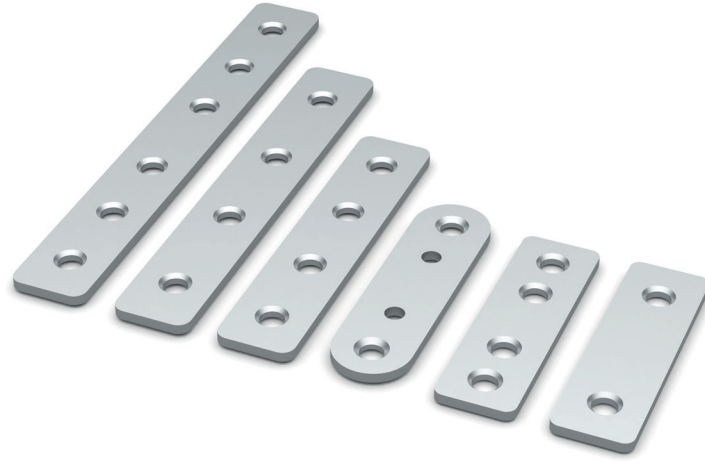

KODU CODE	CİNSİ TYPE	GENİŞLİK WIDTH	UZUNLUK LENGHT	MİNİMUM ADET MINIMUM QUANTITY	KOLİ ADETİ BOX QUANTITY	FİYAT(₺) PRICE
611.111.11	METAL DÜZ GÖNYE 2MM	15	50	250	2 000	1,72
611.119.11	METAL DÜZ GÖNYE 2MM Ç.D	15	50	250	2 000	1,72
611.128.11	METAL DÜZ GÖNYE 2MM	15	54	250	2 000	1,80
611.135.11	METAL DÜZ GÖNYE 2MM	15	70	250	2 000	2,16
611.142.11	METAL DÜZ GÖNYE 2MM	15	90	250	1 000	3,30
611.159.11	METAL DÜZ GÖNYE 2MM	15	110	250	1 000	3,80

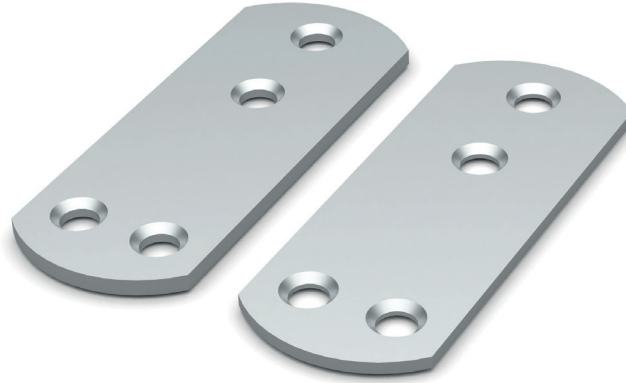

KODU CODE	CİNSİ TYPE	GENİŞLİK WIDTH	UZUNLUK LENGHT	MİNİMUM ADET MINIMUM QUANTITY	KOLİ ADETİ BOX QUANTITY	FİYAT(₺) PRICE
611.210.11	METAL DÜZ GÖNYE 1,50MM	23	60	250	1 500	2,44
611.227.11	METAL DÜZ GÖNYE 2MM	23	60	250	1 500	2,90

FİYATLARIMIZA KDV DAHİL DEĞİLDİR



KODU CODE	CİNSİ TYPE	GENİŞLİK WIDTH	UZUNLUK LENGHT	MİNİMUM ADET MINIMUM QUANTITY	KOLİ ADETİ BOX QUANTITY	FİYAT(₺) PRICE
611.319.11	METAL DÜZ GÖNYE 2MM	30	50	250	2 000	3,10
611.326.11	METAL DÜZ GÖNYE 2MM	30	70	250	1 500	4,50
611.333.11	METAL DÜZ GÖNYE 2MM	30	90	250	1 000	5,80
611.340.11	METAL DÜZ GÖNYE 2MM	30	110	250	1 000	7,10



KODU CODE	CİNSİ TYPE	GENİŞLİK WIDTH	UZUNLUK LENGHT	MİNİMUM ADET MINIMUM QUANTITY	KOLİ ADETİ BOX QUANTITY	FİYAT(₺) PRICE
611.418.11	METAL DÜZ GÖNYE 2MM	40	80	100	1 000	7,50
611.425.11	METAL DÜZ GÖNYE 2MM	40	100	100	800	9,20
611.432.11	METAL DÜZ GÖNYE 2MM	40	120	50	400	11,70
611.449.11	METAL DÜZ GÖNYE 3MM	40	150	50	200	20,00
611.456.11	METAL DÜZ GÖNYE 2MM	40	160	50	400	14,30
611.463.11	METAL DÜZ GÖNYE 2MM	40	200	50	400	18,70

FİYATLARIMIZA KDV DAHİL DEĞİLDİR

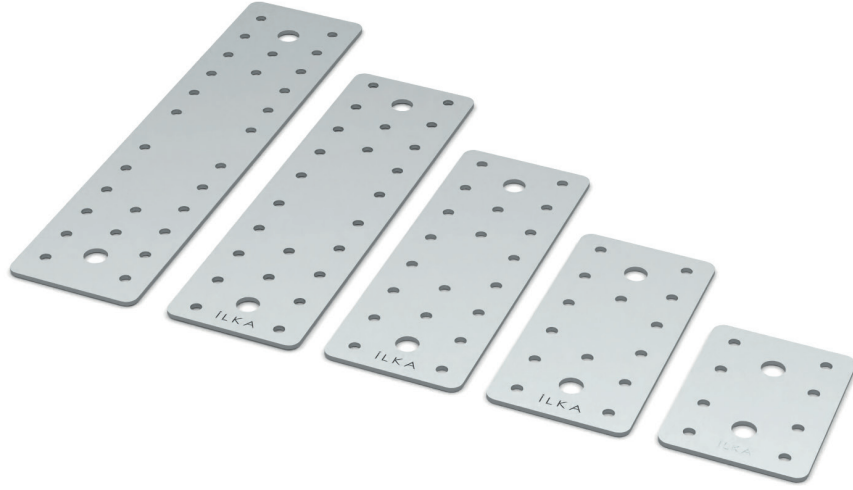

KODU CODE	CİNSİ TYPE	GENİŞLİK WIDTH	UZUNLUK LENGHT	MİNİMUM ADET MINIMUM QUANTITY	KOLİ ADETİ BOX QUANTITY	FİYAT(₺) PRICE
611.616.11	METAL DÜZ GÖNYE 2MM	60	80	100	400	11,00
611.623.11	METAL DÜZ GÖNYE 2MM	60	120	50	400	16,50
611.609.11	METAL DÜZ GÖNYE 3MM	60	150	50	200	30,00
611.630.11	METAL DÜZ GÖNYE 2MM	60	160	50	200	24,00
611.647.11	METAL DÜZ GÖNYE 2MM	60	200	50	200	27,00
611.654.11	METAL DÜZ GÖNYE 2MM	60	240	50	200	33,00

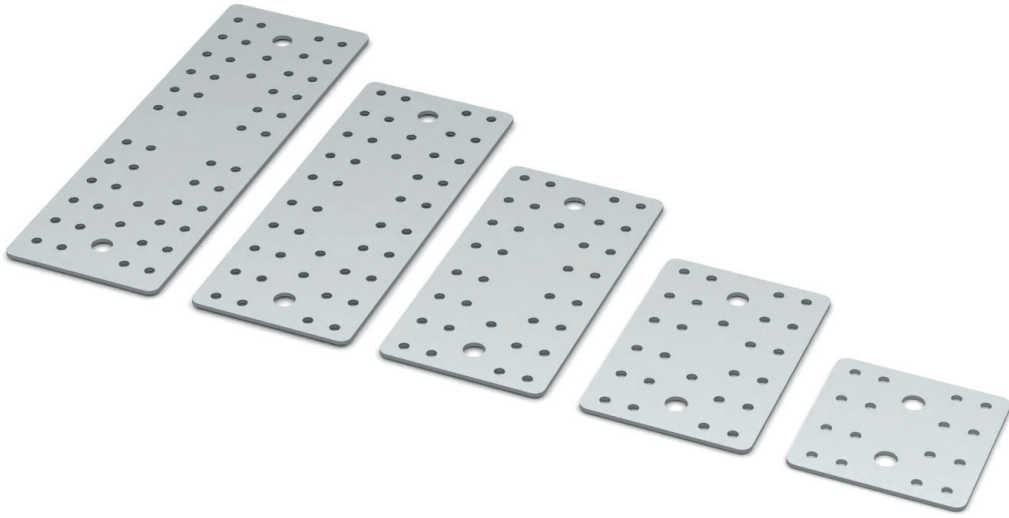

KODU CODE	CİNSİ TYPE	GENİŞLİK WIDTH	UZUNLUK LENGHT	MİNİMUM ADET MINIMUM QUANTITY	KOLİ ADETİ BOX QUANTITY	FİYAT(₺) PRICE
611.814.11	METAL DÜZ GÖNYE 2MM	80	80	50	400	14,30
611.821.11	METAL DÜZ GÖNYE 2MM	80	120	50	300	23,00
611.838.11	METAL DÜZ GÖNYE 2MM	80	160	50	200	28,60
611.845.11	METAL DÜZ GÖNYE 2MM	80	200	50	200	37,40
611.852.11	METAL DÜZ GÖNYE 2MM	80	240	50	200	44,00

FİYATLARIMIZA KDV DAHİL DEĞİLDİR



KODU CODE	Cinsi TYPE	MİNİMUM ADET MINIMUM QUANTITY	KUTU ADETİ BOX QUANTITY	FİYAT(₺) PRICE
19.90.025	İMPACT BİTS UÇ PZ2 25	50	500	14,26
19.90.050	İMPACT BİTS UÇ PZ2 50	25	250	25,27
19.90.090	İMPACT BİTS UÇ PZ2 90	20	100	57,08



KODU CODE	Cinsi TYPE	MİNİMUM ADET MINIMUM QUANTITY	KUTU ADETİ BOX QUANTITY	FİYAT(₺) PRICE
20.90.025	İMPACT BİTS UÇ PH2 25	50	500	14,26
20.90.050	İMPACT BİTS UÇ PH2 50	25	250	25,27
20.90.090	İMPACT BİTS UÇ PH2 90	20	100	57,08

FİYATLARIMIZA KDV DAHİL DEĞİLDİR

Güçlü Manyetik Bits Uzatmalar Stoklarımızda!

Yüksek manyetik gücü sayesinde bits uçlarınızı sıkıca kavrayan, dayanıklı ve uzun ömürlü İLKA manyetik bits uzatmalar artık piyasanın en uygun fiyatlarıyla stoklarımızda! Profesyonel işlerinizde hız ve verimlilik için hemen sipariş verin.



KODU CODE	CİNSİ TYPE	MİNİMUM ADET MINIMUM QUANTITY	KUTU ADETİ BOX QUANTITY	FİYAT(₺) PRICE
37.90.060	MANYETİK BİTS UZATMA 10*60	100	600	100,30

FİYATLARIMIZA KDV DAHİL DEĞİLDİR

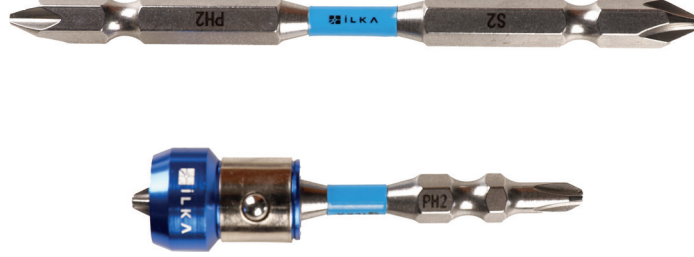

KODU CODE	ÇİNSİ TYPE	MİNİMUM ADET MINIMUM QUANTITY	KUTU ADETİ BOX QUANTITY	FİYAT(₺) PRICE
38.89.019	ÖZEL POZİDRİV (PZ) BİTS SET	10	100	116,80
38.89.020	ÖZEL PHILLIPS (PH) BİTS SET	10	100	116,80



KODU CODE	ÇİNSİ TYPE	MİNİMUM ADET MINIMUM QUANTITY	KUTU ADETİ BOX QUANTITY	FİYAT(₺) PRICE
39.89.019	ÖZEL YÜZÜKLÜ BİTS UÇ PZ2 65	10	100	39,48
39.89.020	ÖZEL YÜZÜKLÜ BİTS UÇ PH2 65	10	100	39,48

FİYATLARIMIZA KDV DAHİL DEĞİLDİR



KODU CODE	CİNSİ TYPE	MİNİMUM ADET MINIMUM QUANTITY	KUTU ADETI BOX QUANTITY	FİYAT(₺) PRICE
19.89.025	BİTS UÇ PZ2 25	60	600	7,46
20.89.025	BİTS UÇ PH2 25	60	600	7,46
19.89.050	BİTS UÇ PZ2 50	30	300	15,35
20.89.050	BİTS UÇ PH2 50	30	300	15,35
19.89.075	BİTS UÇ PZ2 75	20	200	23,89
20.89.075	BİTS UÇ PH2 75	20	200	23,89
19.89.100	BİTS UÇ PZ2 100	10	100	36,21
20.89.100	BİTS UÇ PH2 100	10	100	36,21
19.89.150	BİTS UÇ PZ2 150	10	100	52,73
20.89.150	BİTS UÇ PH2 150	10	100	52,73
19.89.200	BİTS UÇ PZ2 200	10	100	81,24
20.89.200	BİTS UÇ PH2 200	10	100	81,24



KODU CODE	CİNSİ TYPE	MİNİMUM ADET MINIMUM QUANTITY	KUTU ADETİ BOX QUANTITY	FİYAT(₺) PRICE
17.89.025	BİTS UÇ PZ1 25	60	600	7,46
18.89.025	BİTS UÇ PH1 25	60	600	7,46
17.89.050	BİTS UÇ PZ1 50	30	300	15,35
18.89.050	BİTS UÇ PH1 50	30	300	15,35



KODU CODE	CİNSİ TYPE	MİNİMUM ADET MINIMUM QUANTITY	KUTU ADETİ BOX QUANTITY	FİYAT(₺) PRICE
21.89.025	BİTS UÇ PZ3 25	60	600	7,46
22.89.025	BİTS UÇ PH3 25	60	600	7,46
21.89.050	BİTS UÇ PZ3 50	30	300	15,35
22.89.050	BİTS UÇ PH3 50	30	300	15,35
21.89.075	BİTS UÇ PZ3 75	20	200	23,89
22.89.075	BİTS UÇ PH3 75	20	200	23,89



KODU CODE	CİNSİ TYPE	MİNİMUM ADET MINIMUM QUANTITY	KUTU ADETİ BOX QUANTITY	FİYAT(₺) PRICE
41.89.050	TORX BİTS UÇ T30 50	30	300	15,35
41.89.075	TORX BİTS UÇ T30 70	20	200	23,89



KODU CODE	CİNSİ TYPE	MİNİMUM ADET MINIMUM QUANTITY	KUTU ADETİ BOX QUANTITY	FİYAT(₺) PRICE
40.89.008	SOMUN ADAPTÖR 8X45	10	100	32,55
40.89.010	SOMUN ADAPTÖR 10X65	8	80	36,50



KODU CODE	CİNSİ TYPE	MINIMUM ADET MINIMUM QUANTITY	KOLİ ADETİ BOX QUANTITY	FİYAT(₺) PRICE
27.88.001	METAL BAS-AÇ	100	500	40,00



www.ilkaplastik.com



Adres: İstasyon Mah. 1495/2 Sk.
No: 8 Gebze / KOCAELİ

İletişim: 0(262) 656 12 25 - +90 532 509 25 00

siparis@ilkaplastik.com
b2b@ilkaplastik.com